

INPLANTING

Schaal 1:200

Wijziging Bouwplan Garage
dhr en mev. VERCAMMEN - Van kennel
Zwaluwstr 10 Bocholt-Kaulilla
Afd 3 Sectie A nr. 100 H. 10

Gemeente BOCHOLT

Plan gevoegd bij bouwvergunning
nr. 18.001.2005/217

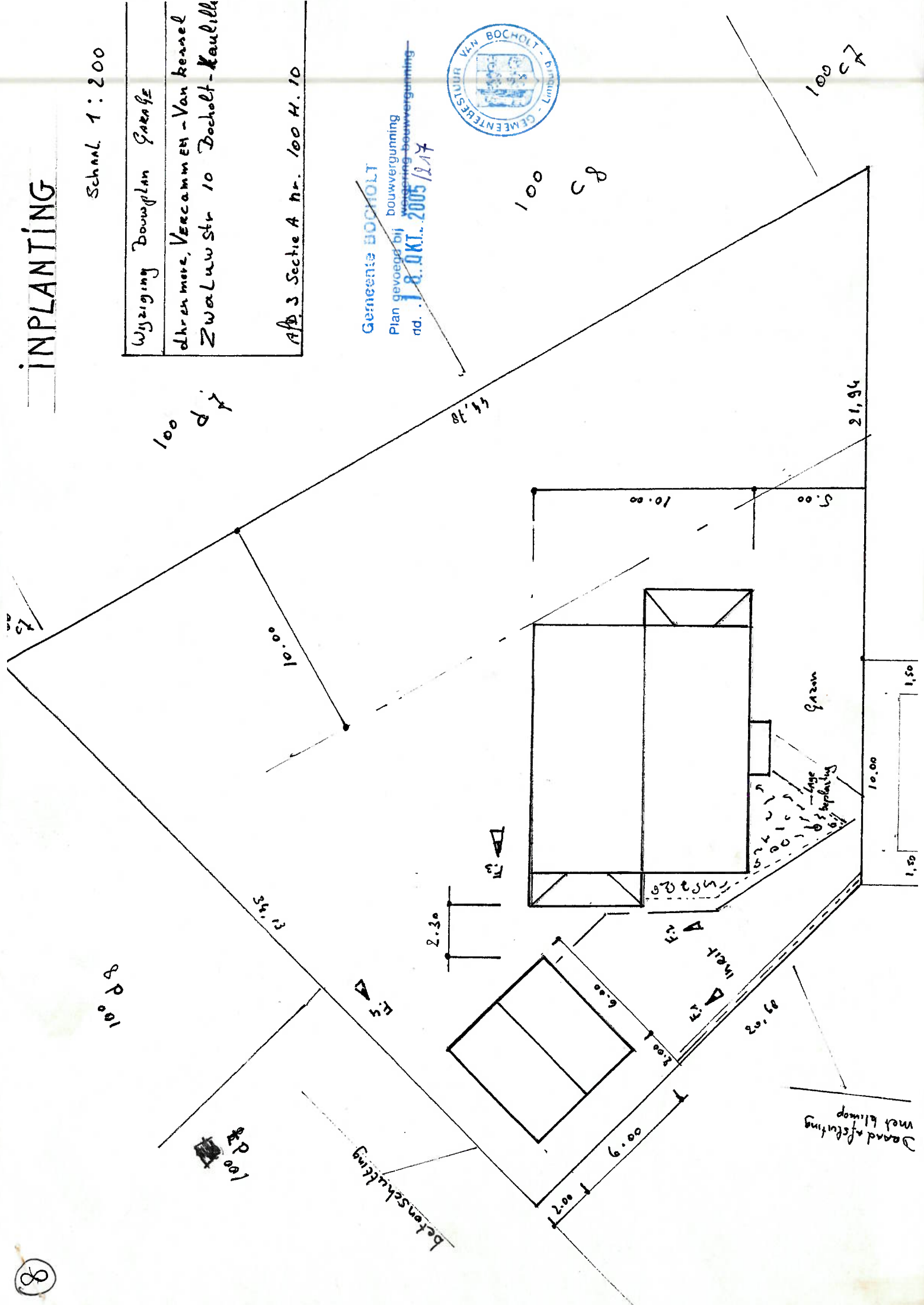

wijziging bouwplan GARAGE

chr. en here. Vercaemen - Vanbessel
Zwaluwstr. 10 Dochoft-Kaulif

Afd. 3 sectie A nr 100 H 10

PLAN bevat 8 BLZ

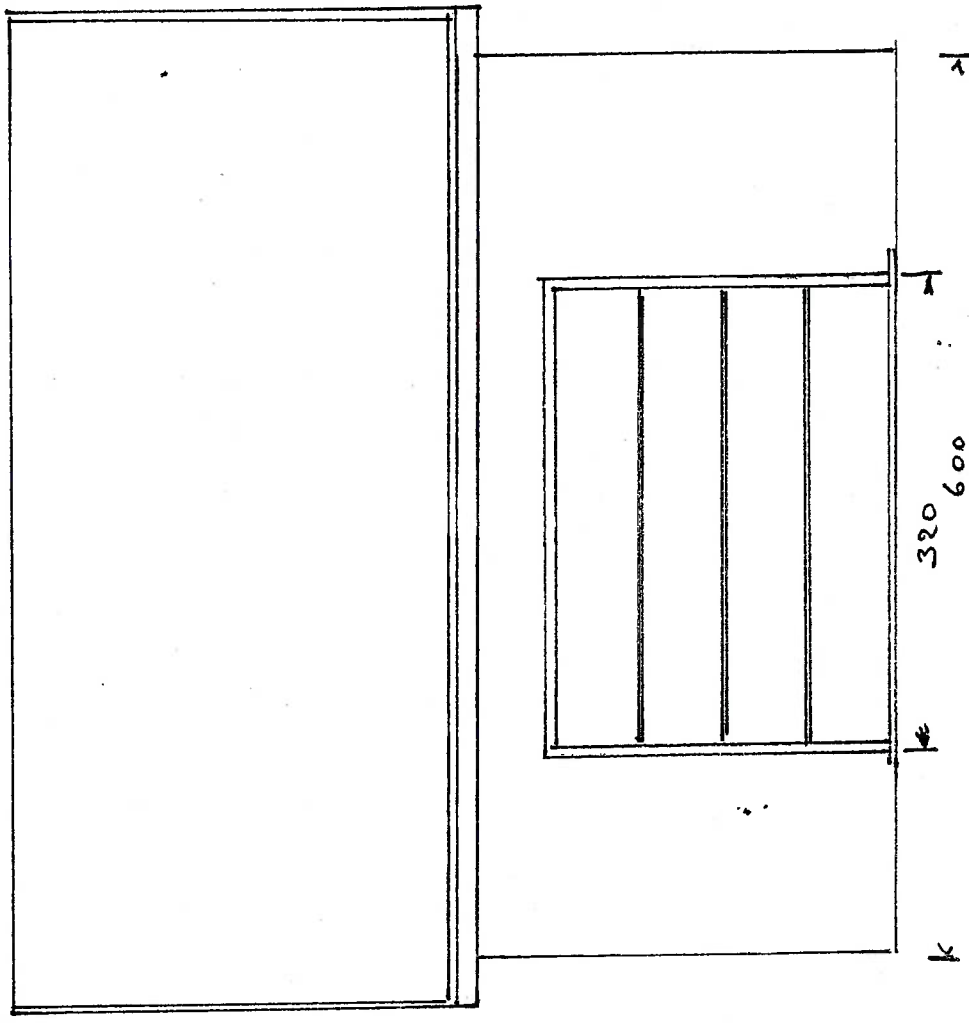

Bouwmaterialen

- Van - Gevel
 - Dak
 - Ramen-Deuren
- zelfde als woning

VOORGEVEL

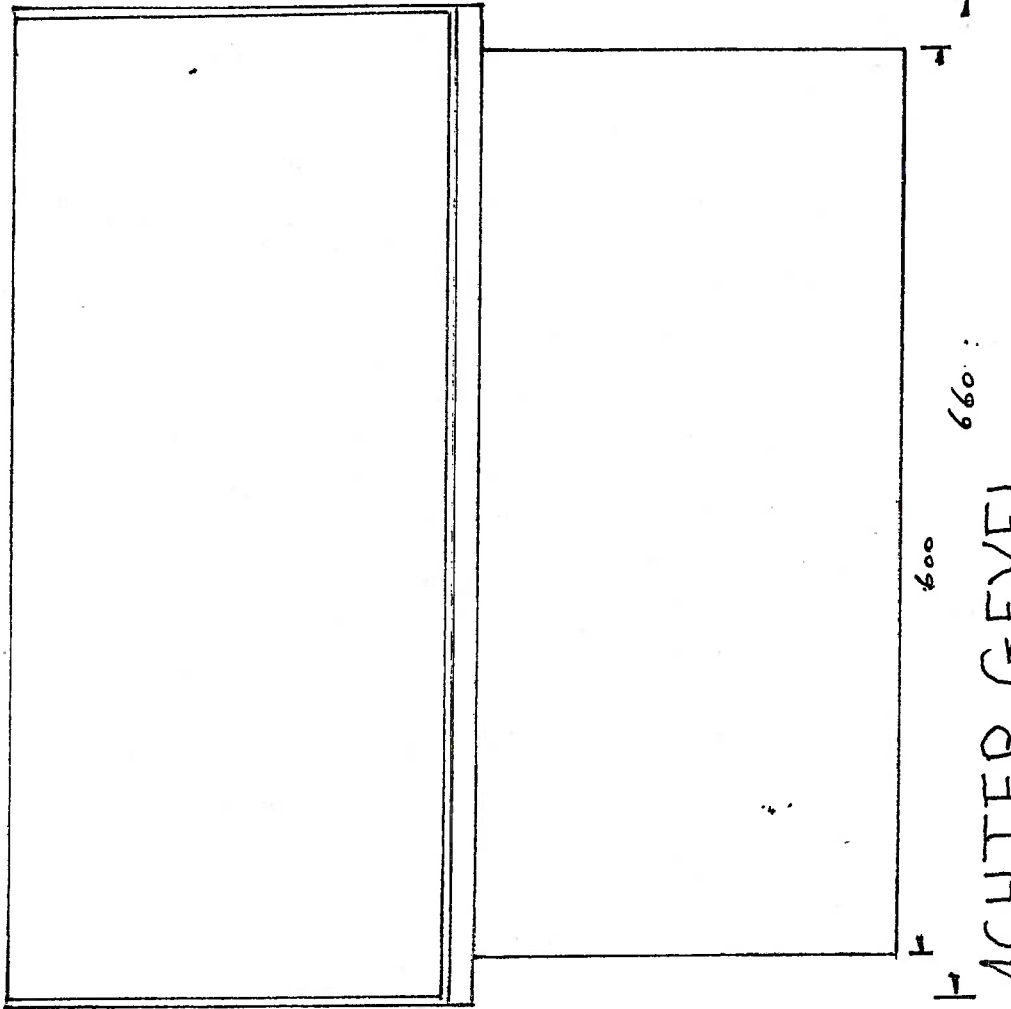

600
660
ACHTER GEVEL

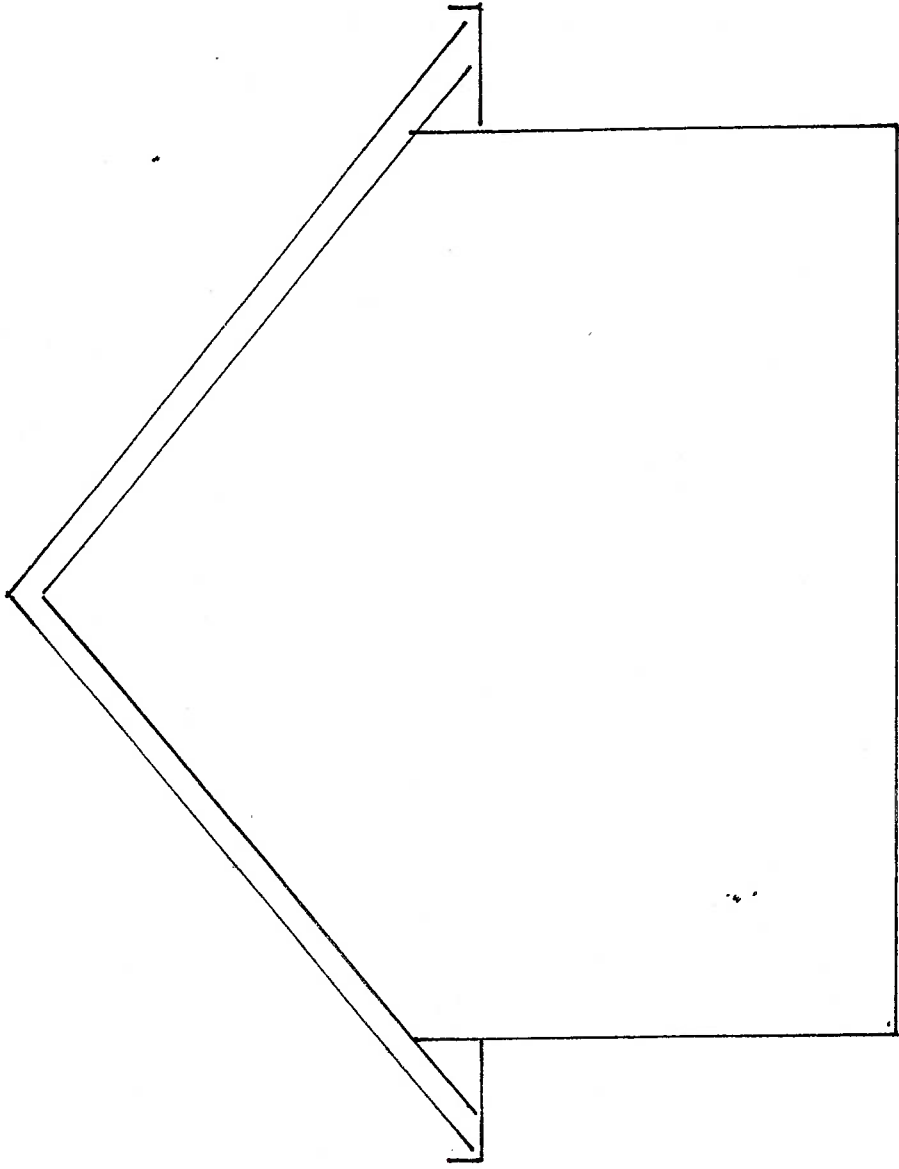

ZIJ GEVEL LINKS

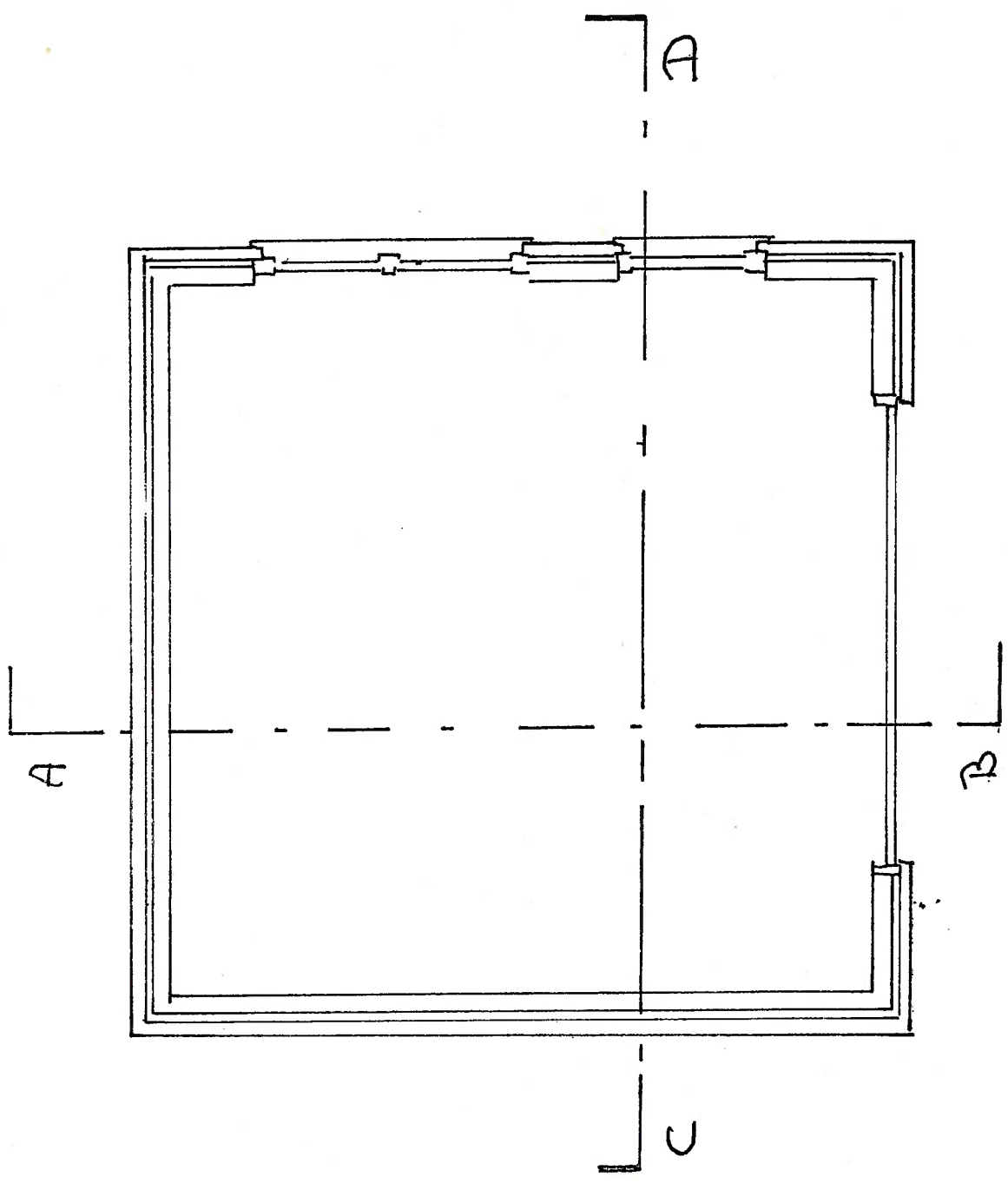

GROND PLAN

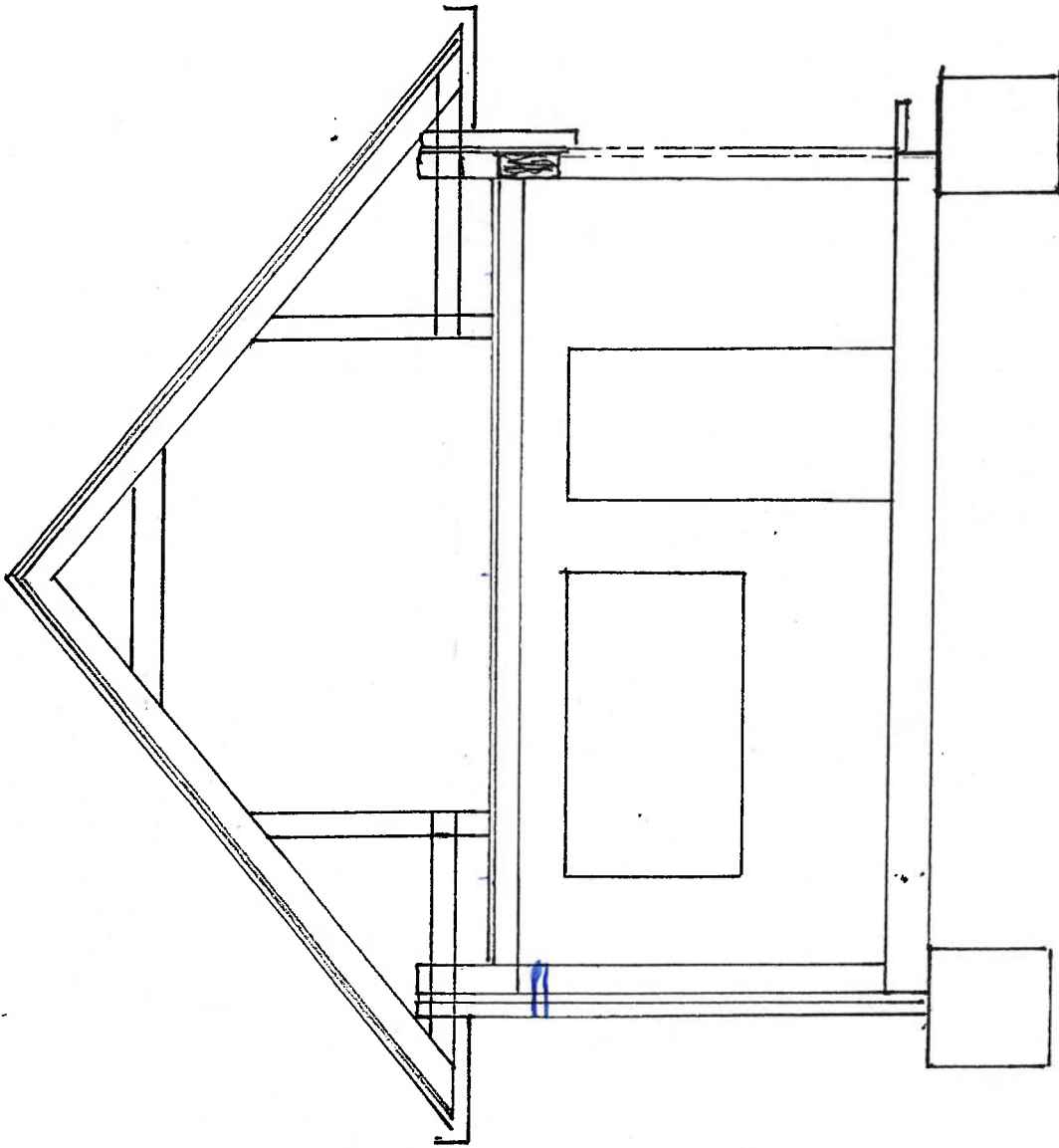

DOORSNEDE A-B

7

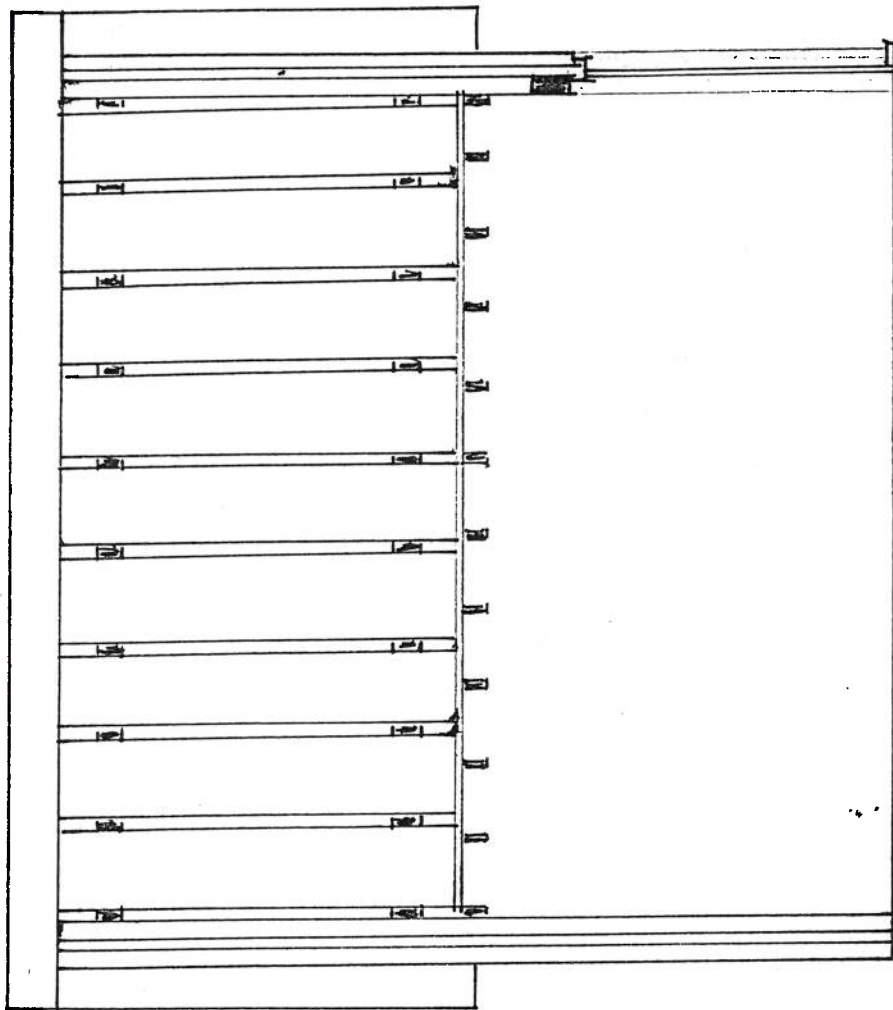

DOORSNEDE C-D

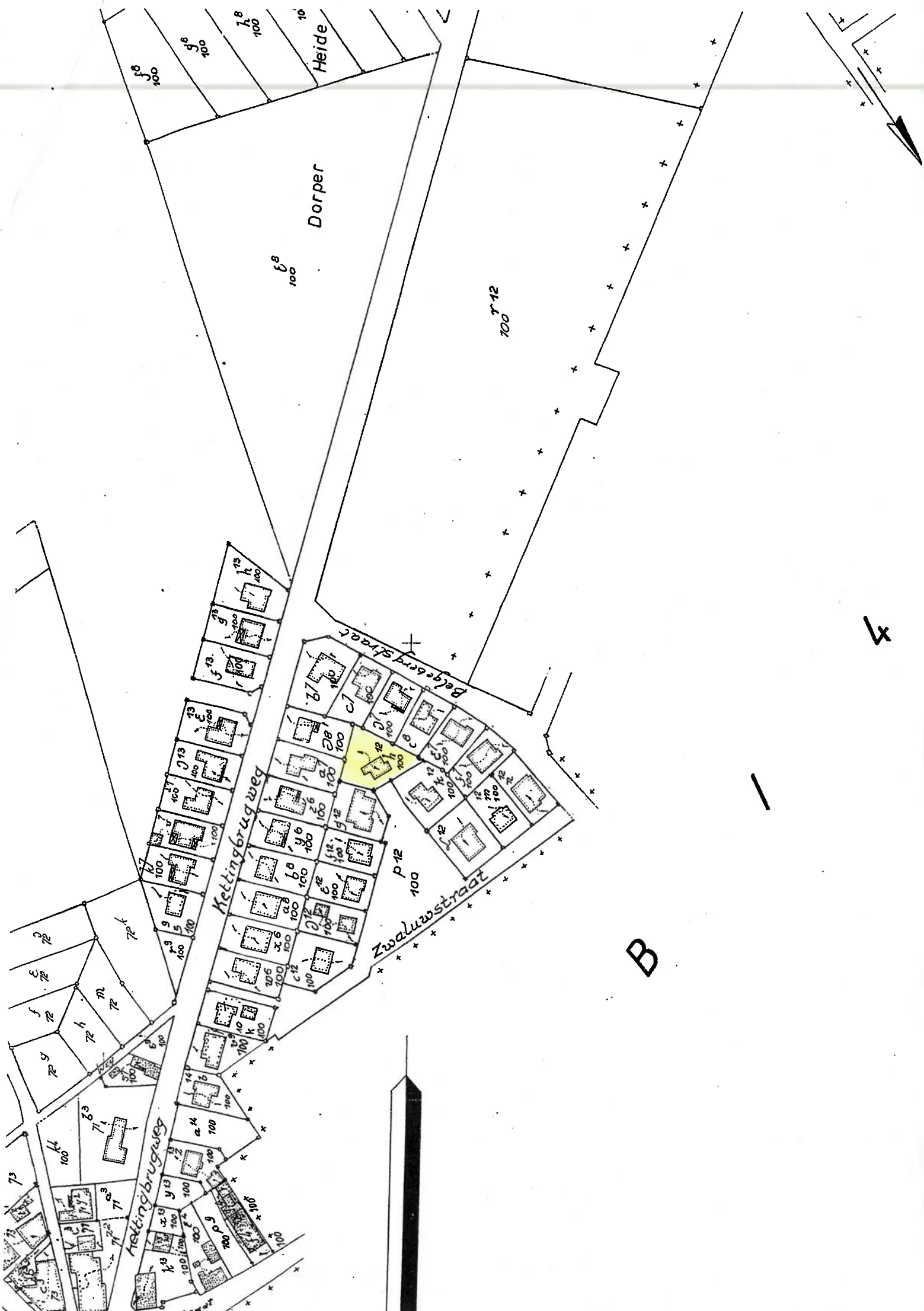

4

B